

MAX4 SINGLE PENDANT Installation Instructions

Overview

WARNINGS

- This product must be installed in accordance with all applicable codes by a person familiar with the product.
- Each luminaire must be properly supported during install.
- DO NOT join fixtures on the floor prior to lifting, or damage will occur.
- Before beginning installation, review our complete list of warnings by visiting www.saylite.com/warnings.



Texas Fluorescents Reinvented

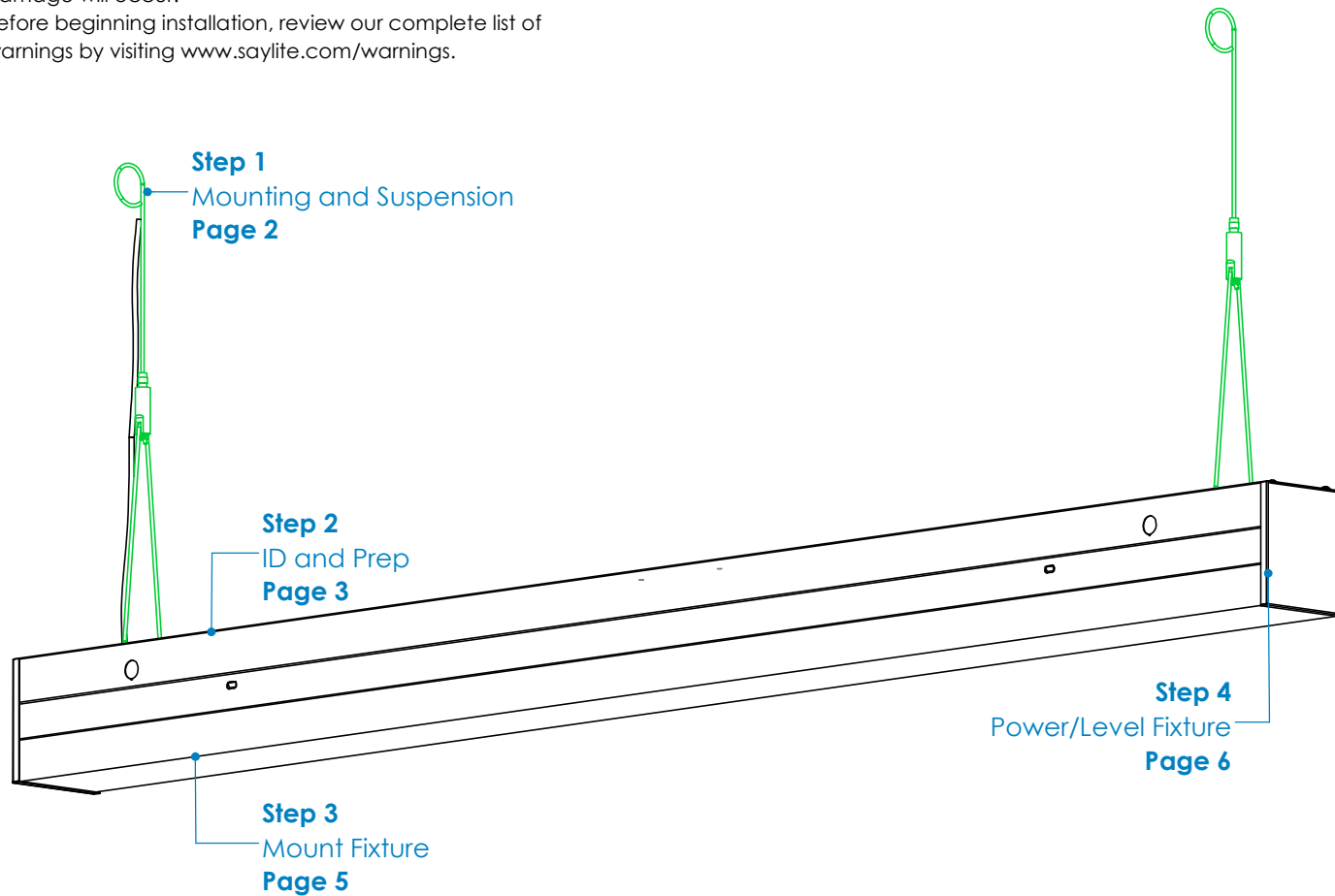

Form MCM - MAX4 Pendant , V1 , 03/20

MAX 4 SINGLE PENDANT Installation Instructions

Step 1 - Mounting and Suspension

Mounting Options

Option 1

Hanging Kit GT310

- Install hanging kit on secure structure
- Ensure cables are installed at mounting locations
- Adjust cables to desired length

Option 2

Hanging Kit GT315

- Install hanging kit on secure structure
- Ensure cables are installed at mounting locations
- Adjust cables to desired length

Suspension Locations

X = Suspension Dimensions

Refer to Assembly Drawings and building plans to determine exact mounting, suspension points, and power feed locations.

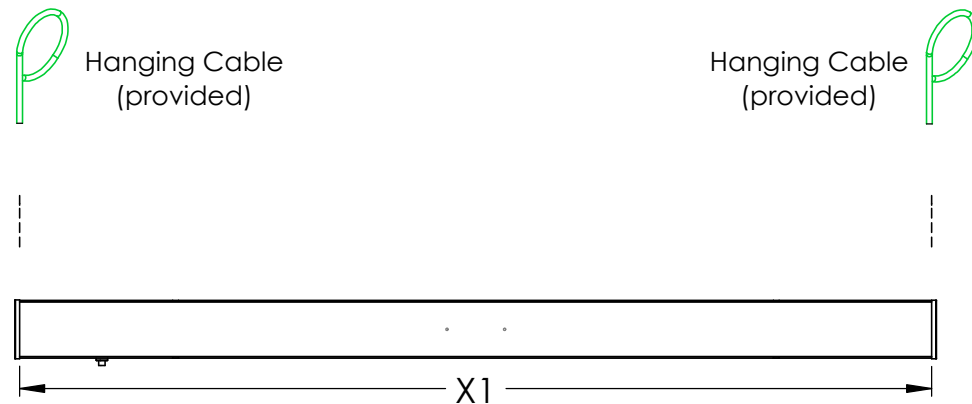

MAX 4 SINGLE PENDANT Installation Instructions

Step 2 - Identification and Preparation

A. Identify Fixtures

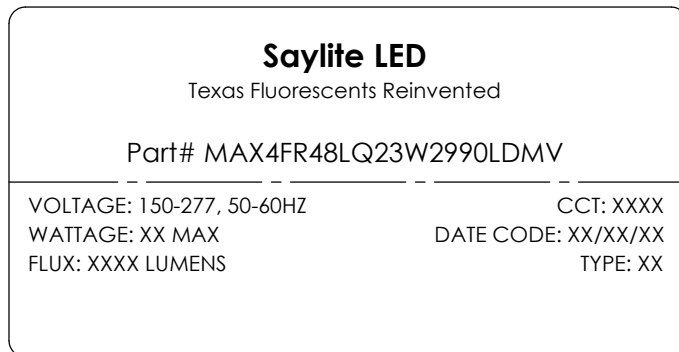

- Use labels found on the box and inside the fixture bodies to identify bodies.
- **NOTE:** Locations of labels can vary.
- Remove all fixtures from their boxes.
- Organize fixtures based on their labels at the install location.

Kitted Hardware

- Saylite has provided the items listed here, with their Saylite part numbers listed. These items can be found in separate boxes shipped with the fixture.
- Ensure all parts are accounted for and set them aside until needed.
- Any additional hardware needed for this installation will be provided by others.



Pendant Mount Kit
PN: GT310A/GT315

B. Tools Needed

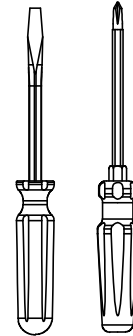

Screwdrivers

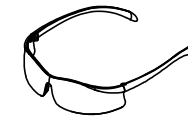

Safety Glasses

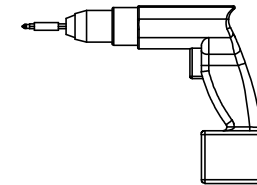

Drill
(optional)

- Always use proper safety equipment when installing fixtures.
- Tools shown are recommended for standard install. Tools needed may vary based on actual install location conditions.

MAX 4 SINGLE PENDANT Installation Instructions

Step 3 - Mount the Fixture

A. Install Hanging Kits

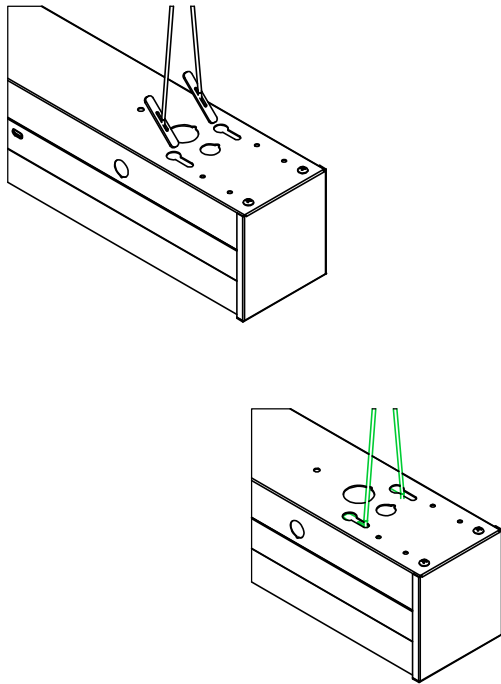

- Install hanging kit on end with pre-installed power cable first.
- To install, rotate the paddles and insert into keyways of the fixture.
- See kit install instructions on GT310/GT315 packaging for details.

B. Connect Fixture Wiring

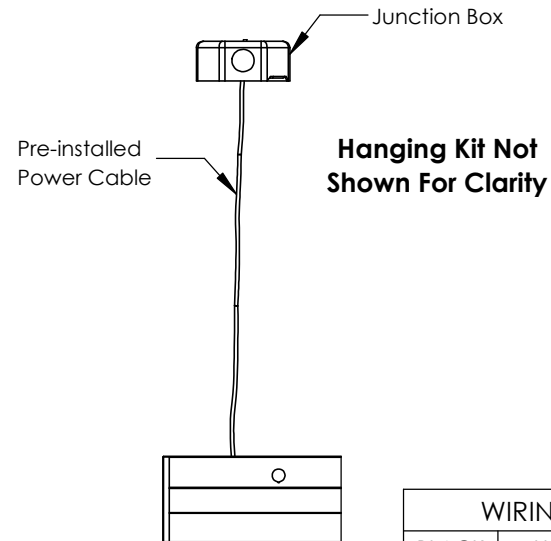

BLACK	HOT	LINE VOLTAGE
WHITE	NEUTRAL	LINE VOLTAGE
GREEN	GROUND	
GRAY	DIMMING	0-10V DC
VIOLET	DIMMING	0-10V DC

- This model comes with a pre-installed power cable and junction box.
- Wire the fixture to incoming power supply according to all local, state and national codes.
- Do not power the fixture until the next step is complete.

MAX 4 SINGLE PENDANT Installation Instructions

Step 4 - Power and Level the Fixture

A. Secure the Power Cable

Secure Power Cable
To Pendant
Using Zip Ties

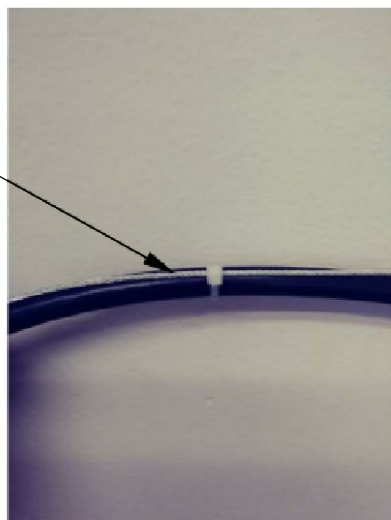

B. Level the Fixture

ADJUST CABLES TO
LEVEL FIXTURE

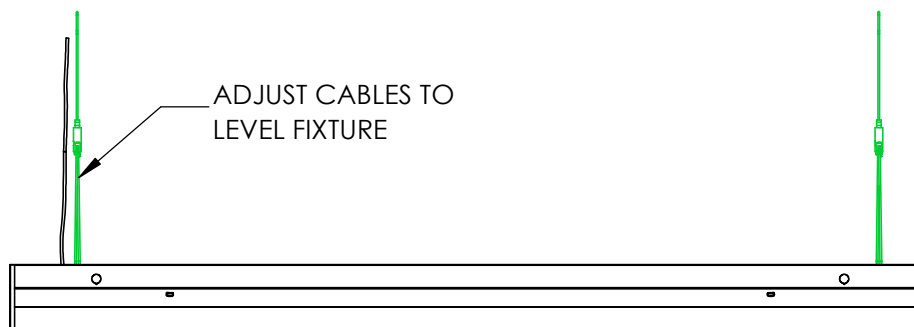

- Secure the power cable to the pendant cable using zip ties.
- Secure the power cable to the power feed canopy using the cable strain relief.

- Make final adjustments to cables, ensuring fixture is level.
- Fixture install is now complete.